

Sungate

MODEL:CD706A

7 " eReader and Digital Album User manual

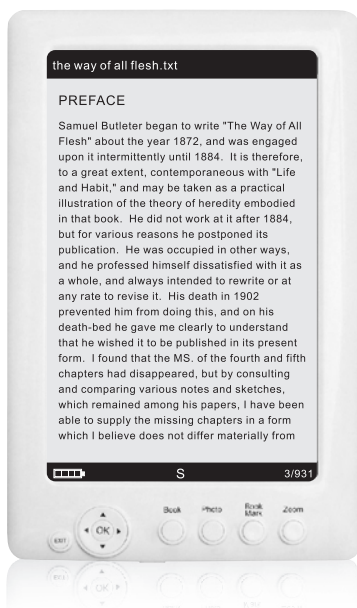

User Notice

This product has met electronic emissions standards required. It can be used safely at home.



Contents

Product introduction and specification

Product introduction and specification 2

Safety precautions

Safety precautions 3

Parts and components

Parts and components 5

Navigation controls

Navigation controls 6

Memory cards and PC connection

Insert a memory card 7

PC connection 8

Getting started

Getting started 9

Basic functions

Books 10

Photos 11

Music/video 12

Clock 13

Dictionary 15

Setting 16

Customer management

FCC and safety information 17

Product introduction and specification

Product introduction and specification

Sungale CD706A is a portable eReader and digital album. With its colorful LCD screen, you can review pictures, enjoy music, watch video, read eBooks and display calendar and clock as well as set up alarm clock. Besides, it has built-in dictionary for unknown words inquiry. It supports files of many formats. Please find its specification as follow:

- ◆Display type: TFT LCD 7 inch (16:9)
- ◆Resolution: 800RGBx480pixels
- ◆Photo file formats: JPG, BMP, PNG, TIFF
- ◆Music file formats: WMA, WAV, OGG, AAC
- ◆Video file formats: AVI, DIVX, XVID, DAT, WMV, 3GP, FLV
- ◆eBook file formats: TXT, EPUB, HTML, FB2, Palmdoc, zTxt, TCR, RTF, OEB,OpenReader, Non-Drm'ed mobipocket
- ◆USB connection: USB device 2.0
- ◆Cards: SD/MMC
- ◆Power supply: AC 100----240V DC 5V 2A
- ◆Battery duration: Read eBooks for around 3 hours, play picture for 3-4 hours, play music or video for 1.5-2 hours.
- ◆Compatible PC system: Windows 2000/XP/Vista/7, Macintosh computer (MAC)

Safety precautions

Safety precautions

Electric safety

Make sure to review the following guidelines to ensure user safety and avoid product failure.

Power Precautions

⚠ WARNING: indicates information that, if neglected, could result in serious injury and/or death to the user.

⚠ CAUTION: indicates information that, if neglected, could result injury to the user and/or material damage.

01. Use only the authorized power supply product. Failure to do so could result in product malfunction.



02. When connecting the power source, make sure that your hands are free of moisture. Failure to do so could result in electrical shock.



03. Make sure that the power supply is firmly plugged in and not loose. Failure to do so could result in electrical shock.

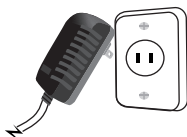

04. Do not let the power cord get overly entangled and do not place any heavy objects on the cord. Failure to do so could result in electrical shock.

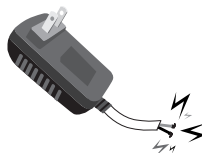

05. Do not connect the power supply to an electrical power strip with other various connections. Failure to do so could result in fire.

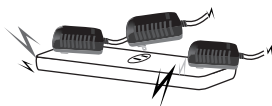

06. Disconnect the power supply during inclement weather conditions that include thunder and lightning. Failure to do so could result in fire.



Safety precautions

Safety precautions

Make sure to review the following guidelines to ensure user safety and avoid product failure.

Product Related

01. Dropping the product or subjecting it to a significant impact can cause critical damage.



02. Spilling water or any other liquid on the product can cause critical damage.



03. Striking or scratching the LCD screen may cause critical damage.

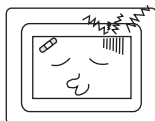

04. When cleaning the LCD screen, turn off the power and wipe it gently with a soft cloth.

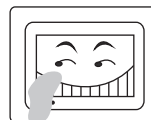

05. Do not subject the product to severe humidity and/or heat.

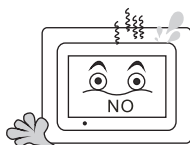

06. Make sure to power off the unit before disconnecting the power supply.

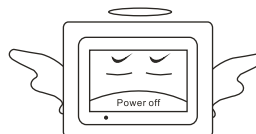

Parts and components

Parts and components

As Sungale is constantly working to improve its products' performance, these components may be modified without notice.

The components may differ slightly in appearance with the images provided.

Basic Components

These components are included with your product.

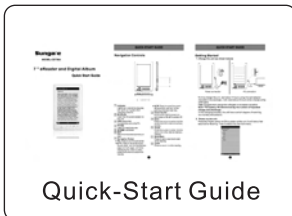
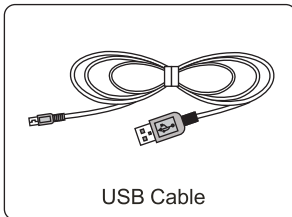
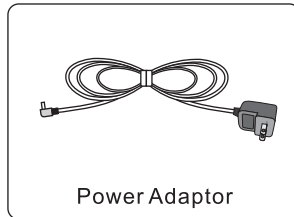

Navigation controls

Navigation controls

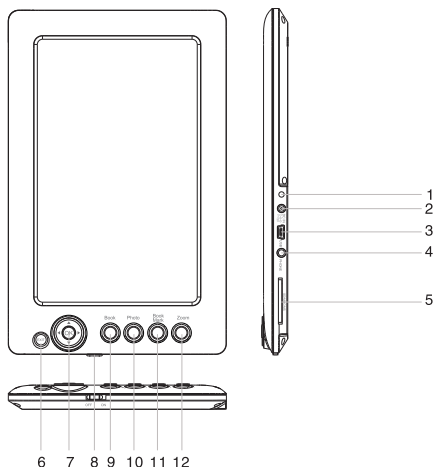

- 1 Indicator**
Lights up in red while charging and lights up in green after charging complete.
- 2 DC IN slot**
Insert the DC power adaptor to the unit.
- 3 USB connector**
Connect the unit to the PC.
- 4 PHONE**
Insert for earphone use.
- 5 SD/MMC card slot**
- 6 EXIT**
Return to the previous menu or item.
- 7 Navigation Button**
 - **OK**: Press to confirm and enter.
 - **▲/▼**: Press to move the cursor up and down, turn to the previous page and next page, and when displaying the video or audio, press the buttons to adjust the volume.
 - **◀/▶**: Press to move the cursor left and right, and turn to the previous row and next row.
- 8 Power Switch**
Press to the right to power on, and press to the left to power off.
- 9 Book**
Press the button to enter into the ebook list in the internal memory directly.
- 10 Photo**
Press the button to enter into the photo list in the internal memory directly.
- 11 Book Mark**
Press to add a new book mark while reading.
- 12 Zoom**
Press to zoom in while reading.

Memory cards and PC connection

Insert a memory card

Insert card in the direction indicated by the arrow on the top of the card. (the side of the memory card on which sticker is affixed should face in the opposite direction as you look at the frame)
SD and MMC cards are compatible with this unit. Aligning the memory card upside down and forcing the card in the frame may cause damage. Please take caution when inserting a memory card.

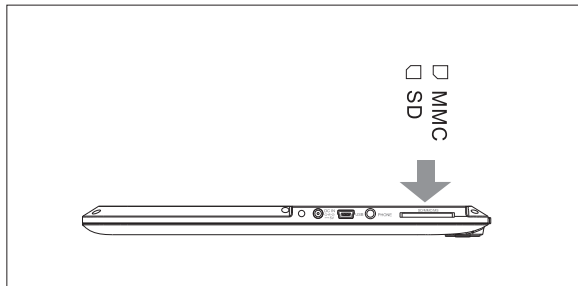

Removing the Memory Card

When removing a memory card from the unit pull the card straight up and away. Avoid bending the card.

Memory cards and PC connection

PC connection

Use the supplied USB cable to connect your Entertainment Station to PC. Insert the small end of the USB cable into the unit and the large end into an open USB slot on your computer. After connection the internal memory and any card inserted into the unit will be accessible in Windows by going to the “MY COMPUTER” Window and accessing the “removable disc” icons(s). Under a Mac OS-X system the unit will show up on the Mac desktop.

To disconnect; Use the “Safely Remove Hardware” icon on the task bar window to remove the device. Then disconnect the USB cable.

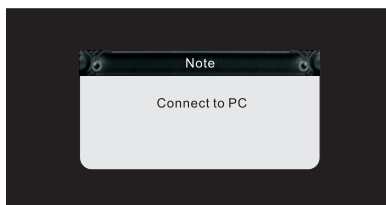

Use ASSP

1. Click "FileConverter.exe" and then click "Add File", your computer's files and folders will appear, double click the file or photo to add them to your eReader.
2. Hold on "Shift" or "Ctrl", you can download multi files or photos to your eReader. In this way, the photos downloaded will be stored at 800 x 600 pixels to suit your eReader screen and the MP3 files will be transferred into WMA file. When you have finished the operation, please safely remove the USB cable from your PC.

Tip: You also can take the eReader as a regular storage device, select the photos from your computer, and then paste them into internal memory of your eReader. In this way, the photos will be stored without compression. If you want to optimize your internal memory, you can select the photos, then click the "Convert".

Attention: Once you format the internal memory of your eReader the ASSP software will be deleted.

In this situation, you can still use the eReader as a regular storage device, you can copy, paste and delete files after connecting your eReader to the PC. But there will be no ASSP tool to convert files anymore.

Getting started

Getting started

Reading eBooks

1. Choosing a book

There are two ways to find books on the unit.

- In the main menu, use the ▲ / ▼ buttons to select the Books menu and press OK.
- Press the Book button.

2. Continue reading

In the main menu, use the ▲ / ▼ buttons to select the Continue Reading menu and press OK to continue reading the ebook from your last session.

3. To turn rows, press the ▲ / ▼ buttons, and press the ◀ / ▶ buttons to turn pages.

4. When reading eBooks in WORD format, the text content will be fully displayed. If there are pictures or diagrams in your WORD format eBook, then the pictures will not be displayed.

5. To add a bookmark, just press the Book Mark button while reading; In the main menu, select the Bookmarks menu and press OK to enter into the bookmark list, select a bookmark and press OK to continue reading.

6. Press “Zoom” to increase the font size.

7. To return to the previous menu, press the Exit button.

Getting eBooks

1. To purchase or download ebooks on internet. Put the purchased or downloaded ebooks to the SD/MMC cards or to your computer.

2. Insert SD/MMC cards to the eReader if there are ebooks in the cards, and the eReader can read the ebooks in the cards directly.

3. If the ebooks are in the computer, use the USB cable to connect the eReader to the computer, copy and paste the ebooks to the storage of eReader. After the file transfer, please Safely Remove Hardware from the PC, and then directly unplug the USB connection, then find and read the ebooks in the storage of eReader.

4. The eReader can support the ebooks formarts as below: TXT, HTML, EPUB, FB2, CHM, PLUCKER, PALMDOC, ZTXT, TCR, RTF, OEB, OPENREADER, NON-DRM'ED MOBIPOCKET, and support plain WORD format ebook text.

Basic functions

Books

When you turn on the machine, it will go to the main menu and the underline will stop at the first option---“Continue Reading”.

Press “OK” button to read the book that you have read last time.

How to read a book in the eReader

If you haven't read any book before, please press ▼ to move the underline to “Books” and press “OK” button to enter the internal memory (or also with SD/MMC card if you have inserted it into your eReader).

Press “OK” to enter “Internal memory”, a folder named “demo” will appear, press OK to enter the eBooks list.

You may also press the “Book” button to enter the eBooks list directly.

Press ▼ / ▲ to move the underline to select a book and press OK to start reading.

When reading a book, press ▼ / ▲ to turn rows, and press ◀ / ▶ to turn pages .

How to set up a bookmark and delete a bookmark

When reading a book and you want to make a bookmark for the present page, press “Book Mark” icon, a quill-pen will appear on the upper-right corner of the screen. Then this page has been bookmarked.

When you read this book next time, go to the main menu and press ▼ to move the underline to “Bookmarks”. Press OK to find the bookmark. And then press OK to enter the bookmark page.

If you want to delete the bookmark, select the bookmark and press OK to enter that page, then press “Book Mark”, the bookmark will be deleted.

Basic functions

Photos







There are two ways to go to photos.

1. In the main menu, press ▼ to move the underline to “Photos” and press OK, you will find “Internal memory” or also with SD/MMC card listed. Press OK to enter. There will be files listed. Press OK to start playing pictures.

2. Press “Photo” button and the pictures names will be listed on the screen. Press OK to start playing pictures.

There will be several icons at the bottom of the screen, there functions are as follow:



-  :Add or close background music
-  :full screen slideshow
-  :last picture
-  :next picture
-  :rotate photos
-  :return

Press ◀ / ▶ to select the 6 icons above and press OK to confirm you selection.

Press “Exit” button to exit.





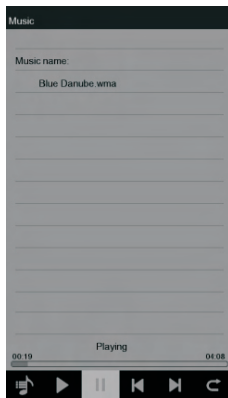

Basic functions

Music

In the main menu, press ▼ to move the underline to “Music” and press OK, you will see “Internal memory” or also with SD/MMC card listed. Press OK to enter the songs list. Then press ▼/▲ to select the song you want to play. And then press OK to play.

There will be several icons at the bottom of the screen, there related functions are as follow:



-  :show songs list
-  :Play
-  :Pause
-  :Last song
-  :Next song
-  :Return

Press “Exit” button to exit.

Video

In the main menu, press ▼ to move the underline to “Video” and press OK, you will see “Internal memory” or also with SD/MMC card listed. Press OK to enter the video files list. Then press ▼/▲ to select the video you want to play. And then press OK to play.

Press ▼/▲ to adjust volume and press ◀/▶ to play the last or next video. Press OK to pause or continue play.

Press “Exit” button to exit.

Basic functions

Clock

How to set up date and time

In the main menu, press ▼ to move the underline to “Clock” and press OK to enter the interface with three options : Set Date, Set Time, Set Alarm. And “Set Date” is highlighted in yellow.

Press OK to set Date and you will enter the interface as follow:



Press ▲/▼ to change month, day and year and press ◀/▶ to move cursor among month, day and year.

Press OK when finished setting. It will return to the clock with calendar interface. Press ▶ to move cursor to “Set Time” and it will be highlighted in yellow. Press OK to confirm. Then press ◀/▶ to move cursor among hour and minute, and press ▲/▼ to change the time. Press OK when finished and it will return to the clock with calendar interface.

How to set up alarm clock

Press ▶ to move cursor to “Set Alarm” and press OK to confirm. Press ◀/▶ to move cursor among time and alarm clock state(OFF/ON), and press ▲/▼ to set up alarm clock time and change alarm clock state between OFF and ON. Press OK when finished setting and it will return to the clock with calendar interface.

Tips: please make sure that your eReader has power and has been turned on when alarm clock time is up, and the alarm clock state has been set up to “ON”, or the alarm clock bell won't ring.

Basic functions

Clock

5 minutes snooze

This alarm clock has 5 minutes snooze function. When time is up, the bell will ring and cursor will stay at “Snooze” for the first time. At this time, if you want 5 minutes snooze, please just press OK and the alarm clock bell will ring again after 5 minutes. Or else press ► then press OK to exit. Then the alarm clock bell won't ring after 5 minutes.

After the first 5 minutes snooze and the alarm clock bell is ringing, the cursor will stay at “Exit” icon. If you just press OK then the alarm clock bell won't ring after 5 minutes. If you need 5 minutes again, you have to press ◀ and then OK to have another 5 minutes snooze.

Press “Exit” button to exit.

Basic functions

Dictionary

In the main menu, press ▼ to move the underline to “Dictionary” and press OK to enter the interface as follow:

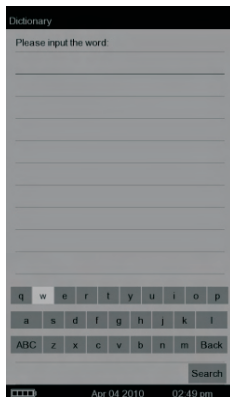

Input the words by using the on-screen-keyboard. Press ◀ / ▶ to move cursor left or right and press ▲ / ▼ to move cursor up and down.

When you finished inputting, move the cursor to “Back” and then press ▼ to move cursor to “Search”, then press OK to search the word. The related word explanation will appear on the screen.

Press ▼ / ▲ to turn rows and press “Exit” button to exit.

Basic functions

Setting

In the main menu, press ▼ to move the underline to “Setting” and press OK to enter the interface with two options: Slideshow interval; Information. The underline will stay at “Slideshow interval”.

Press OK to set up slideshow interval, you may choose 5 seconds, 10 seconds or 15 seconds by pressing ▲ / ▼. And then press OK to confirm. It will go back to the last interface.

Press ▼ to move the underline to “Information” and press OK to find the technology information of your eReader such as software version.

Press “Exit” button to exit.

Customer management

FCC and Safety Information

• FCC Part 15.19

This device complies with Part 15 of the FCC Rules .Operation is subject to the following two conditions: (1) this device may not cause harmful interference , and (2) this device must accept any interference received ,including interference that may cause undesired operation .

• FCC part 15.21

Warning: Changes or modifications to this unit not expressly approved by the party responsible for compliance could void the user's authority to operate the equipment.

• FCC part 15.105

Note : This equipment has been tested and found to comply with the limits for a Class B digital device ,pursuant to Part 15 of the FCC Rules, These limits are designed to provide reasonable protection against harmful interference in a residential installation .This equipment generates, uses, and can radiate radio frequency energy and ,if not installed and used in accordance with the instructions, may cause harmful interference will not occur in a particular installation .If this equipment does cause harmful interference to radio or television reception ,which can be determined by turning the equipment off and on ,the user is encouraged to correct the interference by one or more of the following measures:

- Reorient or relocate the receiving antenna.
- Increase the separation between the equipment and receiver.
- Connect the equipment into an outlet on circuit different form that to which the receiver is connected.
- Consult the dealer or an experienced radio TV technician for help.

LIMITED WARRANTY

The limited warranty set forth below is given by the manufacturer with respect to Sungale brand DPF players and other consumer electronics products purchased and used in the United States of America. The manufacturer warrants this product against defects in material or workmanship as follows:

LABOR: For a period of ninety (90) days from the date of purchase if this Product is defective, the manufacturer will repair or replace the Product, at its option, at no charge. After this ninety (90) days period up to one year, a labor charge of US\$30.00 will be charged for each service.

PARTS: For a period of one year from the date of purchase, the manufacturer will supply, at no charge, new or rebuilt replacement parts in exchange for defective parts. After this one year period, the manufacturer will charge the new or replacement parts.

This warranty does not cover: (1) customer instruction, installation or set up; (2) cosmetic damage or damage due to accident, misuse, abuse, or negligence; (3) commercial use of the Product; (4) modification of any part of the Product; (5) damage due to improper operation, improper maintenance, or connection to an improper voltage supply; (6) damage due to an attempted repair of the Product by anyone other than a facility authorized by the manufacturer to service the Product; (7) consumables (such as fuses and batteries). This warranty is valid only in the United States.

The product must be accompanied by a copy of the original retail purchase receipt. If no proof of purchase is attached, the warranty will not be honored and repair cost will be charged.

This warranty is valid with attach written documentation detailing the complaint to the outside or inside of the carton.

This warranty is invalid if the factory applied serial number has been altered or removed from the Product.

The manufacturer reserves the right to modify any design of this product without prior notice.

To obtain warranty service, you must deliver the product freight prepaid, in either its original packaging or packaging affording an equal degree of protection, plus proof of purchase, to:

Service Center
13941 Central Ave,
Chino, CA 91710
Tel: **800-473-5156**

REPAIR OR REPLACEMENT AS PROVIDED UNDER THIS WARRANTY IS THE EXCLUSIVE REMEDY OF THE CONSUMER. THE SERVICE CENTER SHALL NOT BE LIABLE FOR ANY INCIDENTAL OR CONSEQUENTIAL DAMAGES FOR BREACH OF ANY EXPRESS OR IMPLIED WARRANTY ON THIS PRODUCT. EXCEPT TO THE EXTENT PROHIBITED BY APPLICABLE LAW, ANY IMPLIED WARRANTY OF MERCHANTABILITY OR FITNESS FOR A PARTICULAR PURPOSE ON THIS PRODUCT IS LIMITED IN DURATION TO THE DURATION OF THIS WARRANTY.

Some states do not allow the exclusion or limitation of incidental or consequential damages, or allow limitations on how long an implied warranty lasts, so the above limitations or exclusions may not apply to you. This warranty gives you specific legal rights, and you may have other rights which vary from state to state.

